



Product Information
Version 1.0

ZEISS Stemi 305

Compact Size, Big Impact: Your Stereo Microscope
with Integrated Illumination and Documentation



We make it visible.

All-in-one design. Easy to Use. Easy Documentation, too.

- › **In Brief**

- › The Advantages

- › The Applications

- › The System

- › Technology and Details

- › Service

Stemi 305 is your compact stereo microscope with a 5:1 zoom – equally at home in the biology classroom, research lab or on the industrial shop floor. Choose between predefined microscope sets to get the optimal illumination equipment for your applications. Stemi 305 lets you observe samples as they really are: three-dimensional and crisp in contrast – no preparation needed. Enjoy all the advantages of an easy-to-use microscope with integrated LED illumination for reflected and transmitted light – plus fast, easy-to-use documentation. Just snap your images with the integrated 1.2 Megapixel Wi-Fi camera and share them using Labscope, the iPad imaging app. Or choose the conventional phototube for access to all ZEISS Axiocam cameras and free ZEN lite imaging software. This Greenough microscope will give you crisp 3D impressions, versatile object illumination and easily acquired images to share, whenever you want.



Simpler. More Intelligent. More Integrated.

- › In Brief
- › **The Advantages**
- › The Applications
- › The System
- › Technology and Details
- › Service

More than Design. All-in-One Device.

It's compact and it's fun. Yet Stemi 305 integrates everything you need into a single Greenough stereo microscope. Just plug it in and switch it on – that's the installation done, with no extra accessory boxes or cables to clutter up your space. Then all you have to do is illuminate your object, focus and start snapping images. Use Stemi 305 cam with on-board Wi-Fi camera to easily save your results, share them and collaborate on projects with friends, colleagues and classmates. Store Stemi 305 away when work is done, then take it out and get started again in minutes.

Illumination. Crisp for Any Application.

Despite its ease of use, Stemi 305's integrated illumination is variable to contrast every specimen at its best. Simply press a button to select and combine up to two reflected light contrasts and transmitted light. While each zoom body is equipped with near-vertical light to illuminate deepenings in the sample, the second reflected light and transmitted light units are interchangeable. This enables predefined microscope sets for education, laboratory or industrial use to optimize contrast in your application range. White LEDs in your Stemi 305 generate the brightlight of daylight color so each image appears crisp and clear. What's more, long-life LEDs are noiseless, maintenance-free – and real energy savers.

Documentation. Integrated and Wireless.

Documentation is important for lab work, essential for industrial inspection. In the classroom your ability to acquire and share images is a key resource for vivid, exciting science courses. Stemi 305 comes with two options for documentation. Choose Stemi 305 trino with a conventional phototube for access to any ZEISS Axiacam microscope camera and free ZEN lite imaging software. Or go for Stemi 305 cam with its integrated camera and Wi-Fi router. Create your own virtual classroom by using Labscope, the iPad imaging app, to stream live images from several microscopes to all connected iPads. It's easy to share, compare and discuss the work of all the students on your own wireless network. Fun, too.



Your Insight into the Technology Behind It

- › In Brief
- › **The Advantages**
- › The Applications
- › The System
- › Technology and Details
- › Service

Greenough Stereoscopic Design

The basic idea behind a stereoscopic microscope is simple. It was formulated in 1896 by the biologist Horatio S. Greenough, who wanted to see small biologic samples magnified, but with the same quality as with unaided eyes. In other words, in three dimensions and with all the depth information he needed to understand the irregular shape of his specimen intuitively. He reckoned you could build a microscope with two separate beam paths facing the object from two directions, exactly as human eyes do when observing a small object at a distance of 250 mm. The brain would fuse the two images together and produce a spatial image of the object with a high degree of depth perception. This thinking led to the first factory-produced stereo microscope being developed by ZEISS.

Stemi 305 is a Greenough-type stereo microscope, combined with a continuous 5:1 zoom. It uses long working distances for easy specimen handling and large fields of view. It's compact, rugged, easy to use and easy to maintain, making it especially well-suited for intensive use in applications such as classrooms, where users frequently change, or by three-shift industrial inspection teams.

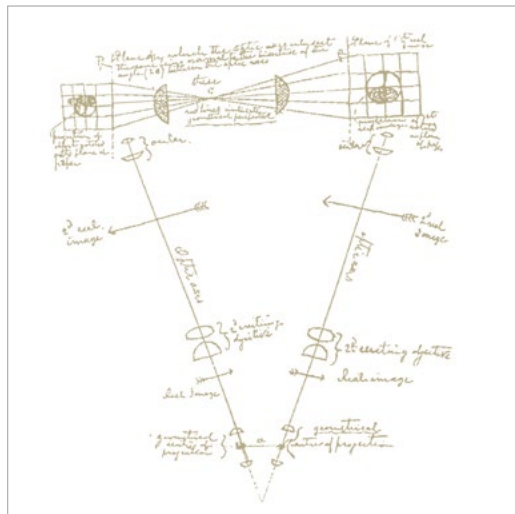

Hand drawing by Horatio S. Greenough (1896), leading to the world's first industrially-manufactured stereo microscope.



Beam path of a Greenough type stereo microscope

Your Insight into the Technology Behind It

- › In Brief
- › **The Advantages**
- › The Applications
- › The System
- › Technology and Details
- › Service

ZEISS Stemi 305 for Education

Easy to Transport. Easy to Install. Easy to Use.

In an academic environment you often have to stow away your systems and just as often set them up again. Storage space is limited. And you work with untrained or changing users. That's why you need a compact stereo microscope that's quick to (de)install and easy to shift – ideally, without extra boxes to cart around or accessories to lose. And of course the microscope must be reliable, robust and easy to use, even if the manual is long gone – and also feature quality optics and those all-important illumination contrasts.

That's a tall order, and precisely why you need the Stemi 305 education set. It has a small footprint and comes with a flat stand base and carrying handle. LED illuminations and power supply are integrated. It's easy to select and combine two reflected light illuminations and transmitted light. Stemi 305 education set provides a near-vertical illuminator to observe holes and cavities, and an oblique light spot. Just plug Stemi 305 in and play.

For a digital classroom environment use Stemi 305 cam with stand K EDU and spot K LED.



Compact and optimized for education use.



Easily switch between vertical illumination, oblique spot or mixed light by the push of a button – and adjust their intensities.



Change height of the spot and zoom in to create distinct shadows for a strong 3D impression. In the lowest position it delivers a grazing light that enhances fine structures on flat surfaces via hard shadows.



Use the flat transmitted light unit to contrast colored transparent specimens in bright- and darkfield. Add polarizer/analyzer equipment to observe, for example, birefringent crystals or tensions in glass or plastics.

Your Insight into the Technology Behind It

- › In Brief
- › **The Advantages**
- › The Applications
- › The System
- › Technology and Details
- › Service

ZEISS Stemi 305 for Laboratory

Versatile Illumination for Sample Preparation

Workspace is always limited in a laboratory where you are observing, preparing or dissecting model organisms and other bio specimens. You may be looking at oocytes or embryos, larvae or adult animals, or at plant components such as roots and leaves. For all these reasons you need variable contrasting methods in transmitted light, but also reflected light. Use the mirror-based transmitted light unit of stand K LAB to observe and manipulate even uncolored transparent specimens. With stand K LAB reflected and transmitted light can be selected easily or combined. To document your results choose Stemi 305 cam or Stemi 305 trino with stand K LAB, double spot K and ergonomic hand rest.



Compact, versatile and well prepared for laboratory work.



The tiltable and shiftable mirror features brightfield, one-sided darkfield and oblique light – plus polarization contrast as an option. Rotate to frosted and plain mirror side, then decide between crisp and diffuse brightfield contrast.

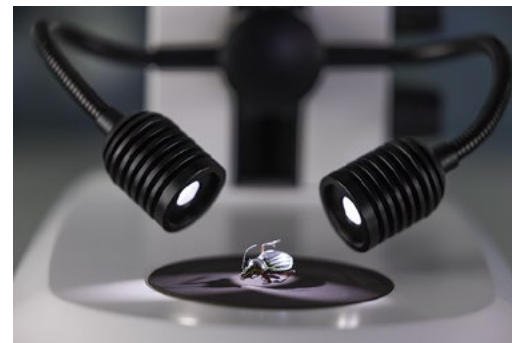

For sample preparations in reflected light, the double spot illumination with self-carrying goosenecks is optimal. It creates half-shadow effects that lead to a good 3D impression without overly dark shadows. During dissections the specimen stays illuminated even if the manipulating hand covers one of the spots.



For extended work add the ergonomic hand rest to keep your hands relaxed, even during long preparations.

Your Insight into the Technology Behind It

- › In Brief
- › **The Advantages**
- › The Applications
- › The System
- › Technology and Details
- › Service

ZEISS Stemi 305 for Industry Segmentable Ringlight for Quick Inspections

Stereo microscopes are essential to everyday routines in your production line or quality department: inspecting, assembling or repairing electronic or optoelectronic components, small mechanical parts, sensors or measuring devices. And if you work in electronic industries your microscopes operate in electrostatic protected areas (EPAs). Choose Stemi 305 MAT for visual inspection or small parts assembly. It provides stand K MAT with reflected light LED controls and anti-static surface resistance to enable use in EPAs. It also includes two reflected light illuminations: the integrated vertical illuminator to look at holes, threads and cavities – and the segmentable ringlight K LED. Simply press the dimming button at the side of the focus column to switch quickly between vertical spot, ring illumination and mixed light. To document or archive your results use Stemi 305 trino with stand K MAT and segmentable ringlight K.



Compact, easy to use and suited for electrostatic protected areas.



The shadow-free ringlight features four different segment modes: full-, half- and quarter-circle and 2-opposite quarter-circle. Set the segment illumination, then turn the light direction manually in 90° steps to quickly inspect for scratches, defects or residues without moving your specimen. Or use auto rotating mode to get a spatial impression of the object surface just by changing shadows.



Stemi 305 is equipped with an integrated near-vertical LED spot to illuminate holes and indentations – even through front optics.

Your Insight into the Technology Behind It

- › In Brief
- › **The Advantages**
- › The Applications
- › The System
- › Technology and Details
- › Service

Document Your Results. Archive and Share.

ZEISS Stemi 305 trino



Enjoy the flexibility of Stemi 305 trino with access to ZEISS Axiocam microscope cameras and ZEN imaging software. The fixed 50/50 division between left eye and camera path is optimal for live demonstrations: your students or customers can follow your microscopic work live on the monitor. Combine Stemi 305 trino with Axiocam ERc 5s and get the advantage of various interfaces: HDMI for direct monitor access, USB to use with Windows PC and free ZEN lite imaging software, or LAN to connect to a digital network and control the camera with the iPad imaging app Labscope.

ZEISS Stemi 305 cam



Stemi 305 cam is your compact and easy-to-use solution for educational tasks. The fast, color Wi-Fi camera and WLAN router are already integrated into the microscope body. In "Access point" mode each Stemi 305 cam creates its own WLAN: up to six iPads can connect directly to the integrated camera and display its live image using the iPad imaging app Labscope. To create a high quality digital classroom, enable "Add to existing WLAN" mode and connect several Stemi 305 cams to the same digital network. Your students can then share their microscope images and collaborate on projects with colleagues and classmates. Let them learn the fun way.

ZEISS Labscope, the iPad Imaging App



The iPad imaging app Labscope displays the live images of all Stemi 305 microscopes in your network to each connected iPad. With one touch you can look at each student's results. It's easy to snap an image, add annotations and measurements, and save it – or export it directly to your server. Once connected to the internet you can share your images, reports or videos with others via email, social media or cloud services. With Labscope, you are saving your images in the ZEN compatible .czi file format including all metadata – or you can select the space-saving .jpg format. Download Labscope free from the Apple App Store.



Expand Your Possibilities

- › In Brief
- › **The Advantages**
- › The Applications
- › The System
- › Technology and Details
- › Service



Choose from a range of interchangeable front optics and eyepieces – and get access to all magnifications between 4x and 200x, double resolution of your Stemi 305 or maximize free working distance and object field.



For demanding samples such as dark specimens, special contrast techniques or critical color evaluations, you will need the separate cold light source CL4500 LED. Enjoy the benefits of its high color rendering index 90 and a large range of fiber optic light guides and accessories. For stands without LED electronics chose between compact stand K or large stand N.



To observe big specimens or to cover a large area of interest, choose from our range of boom stands: stand A with its single extension arm, ball-bearing boom stand SDA for extra stability and easy movement, or tilting arm stand U, well balanced in height to cover large specimen volume. Add the front lens 0.5x to profit from 185 mm working distance.



To position your specimen precisely, use a ball-and-socket, gliding or rotating polarization stage.



Use stand K (version without electronics) and adapt articulating arms to finely adjust light guides.



Controller K powers the integrated Wi-Fi camera, the vertical illuminator or the segmentable ringlight when Stemi 305 is used with boom stands.

Expand Your Possibilities

- › In Brief
- › **The Advantages**
- › The Applications
- › The System
- › Technology and Details
- › Service

Document and archive your results.

And share the images in your digital network.
It is full of possibilities.



In the "Access point" mode each Stemi 305 cam creates its own Wi-Fi net. Up to six iPads can connect to it, display its live image and control the integrated camera.

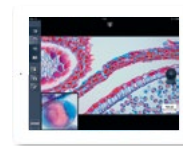
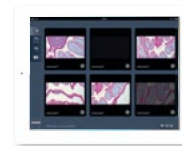

To set up your digital classroom network, switch all Stemi 305 cams to "Connect to existing WLAN" mode. Then connect them to the same Wi-Fi net provided by your external WLAN router. Further ZEISS microscopes or Axiocam cameras may also be connected via a LAN interface. Labscope can then stream the live images of all microscopes to each iPad in the net. It's easy to snap and edit images – and archive them on your local server.

Tailored Precisely to Your Applications

- › In Brief
- › The Advantages
- › **The Applications**
- › The System
- › Technology and Details
- › Service

Typical Applications, Typical Samples	Task	ZEISS Stemi 305 Offers
Education Lab Courses and Advanced Training in:	Study and identify various kinds of unprepared specimen during academic lessons and lab courses.	<ul style="list-style-type: none"> ■ Compact education microscope set including Stemi 305 stereo microscope with 5:1 zoom, compact stand and integrated illumination for reflected and transmitted light. ■ All-in-one design, easy to carry, easy to install and easy to use. ■ Various illumination techniques integrated: Reflected light spot for oblique light. Near vertical spot to illuminate deepenings. Flat transmitted light unit for brightfield and darkfield. ■ Optional equipment for qualitative transmitted light polarization. ■ Using Stemi 305 trino with Axiocam ERc 5s you simultaneously work under the stereo microscope while the live window is displayed on a large HDMI monitor or beamer. ■ Connect several Stemi 305 cam with integrated Wi-Fi cameras to your network. Use free iPad imaging app Labscope to display all live images on each iPad in the net. ■ Stemi 305 laboratory microscope set with mirror based transmitted light unit delivers crisp or homogeneous brightfield, darkfield and oblique light contrast. The latter is needed to contrast uncolored specimen such as <i>C. Elegans</i>. For dissections in reflected light, a double spot gooseneck is integrated. ■ Document highly resolved images using Stemi 305 trino with a ZEISS Axiocam microscope camera. ■ Use Stemi 305 with front lens 0.5x to get a long working distance and flexible tilting arm stand U. The near vertical based illumination of Stemi 305 is shadow free and homogeneous – and always correctly adjusted to the object field. ■ Stand K LAB delivers the oblique light contrast required to evaluate the embryos.
<ul style="list-style-type: none"> ■ Botany 	Investigate the morphology of plant organs.	
<ul style="list-style-type: none"> ■ Zoology 	Study the anatomy of small animals such as worms, snails, spiders, frogs, mice.	
<ul style="list-style-type: none"> ■ Mineralogy 	Study composition and structure of minerals and rocks.	
<ul style="list-style-type: none"> ■ Geology 	Collect and identify micro fossils, such as foraminifera.	
Live Demonstrations	Teach sample preparation or dissection on large screen while the whole class is observing your work.	
Digital Classroom	Connect all microscopes in the classroom and share their live images. Snap, edit and discuss your results easily.	
Laboratory Routine Laboratory Work in Bio Labs	Screen, sort and prepare your plants, animals, embryos, eggs or larvae. Observe, manipulate and dissect model organisms such as <i>Drosophila</i> , <i>C. Elegans</i> , <i>Xenopus</i> or zebrafish. Document your results easily.	
Veterinary Medicine	Look for and identify parasites such as mites, ticks, fleas, and lice, as well as their eggs and larvae. Carry out small animal surgery. Collect and classify horse or cattle embryos for subsequent transfer or for deep freezing for breeding purposes.	

Tailored Precisely to Your Applications

- › In Brief
- › The Advantages
- › **The Applications**
- › The System
- › Technology and Details
- › Service

Typical Applications, Typical Samples	Task	ZEISS Stemi 305 Offers
Industry	Use Stemi 305 for assembly, visual inspection, and repair of various 3D shaped industrial work pieces.	<ul style="list-style-type: none"> ■ Compact Stemi 305 MAT microscope set includes integrated vertical illumination to illuminate holes and deepenings, and a shadow free ringlight. ■ ESD safe by antistatic surface treatment, usable in electrostatic protected areas. ■ The ringlight is segmentable for distinct shadow effects. Quickly change the light direction to find scratches and defects without moving the specimen. ■ To investigate structures of flat surfaces set double arm gooseneck to a low position to create grazing light. To reduce reflections from shiny parts add optional polarization equipment. ■ For large part inspection use cost effective boom stand A in combination with front lens 0.5x. Benefit from the integrated vertical illumination of Stemi 305. ■ To document with highly resolved images use Stemi 305 trino with Axiocam microscope camera. ■ Get the lowest cost imaging from Stemi 305 cam with integrated camera and iPad solution. The images can be archived easily to your local server via wireless LAN.
<ul style="list-style-type: none"> ■ PCB Electronics 	Visual inspection for damage to circuit boards, e.g. oxidation, stress corrosion, inaccurate drill holes.	
<ul style="list-style-type: none"> ■ Entertainment Electronics 	Inspection of the quality of soldered connections, e.g. for improper wiring or for damaged or missing components.	
<ul style="list-style-type: none"> ■ Micro Technology 	Manufacturing, inspection and repair of thick film or hybrid circuits.	
<ul style="list-style-type: none"> ■ Car Industry 	Inspection of injection nozzles, air bags ABS systems. Inspection of large parts, motor or chassis components.	
<ul style="list-style-type: none"> ■ Dental Laboratory 	Finish all-ceramic crowns accurately and reliably, identify and remove casting beads precisely in the framework.	<ul style="list-style-type: none"> ■ Use Stemi 305 flexible tilting arm stand U to share your microscope with two or three work places. The integrated vertical illumination of Stemi 305 is shadow free and homogeneous – and always correctly adjusted to the object field.

ZEISS Stemi 305 at Work

- › In Brief
- › The Advantages
- › **The Applications**
- › The System
- › Technology and Details
- › Service

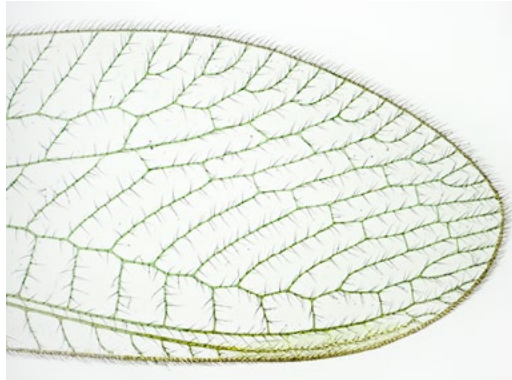

Wing of Chrisopidae; transmitted light brightfield



Feather of hawk; transmitted light brightfield



Grape ivi, appressoria; spot K LED oblique light, zoom 1.2x



Wing of Chrisopidae; transmitted light darkfield



Royal fern, sori and sporangia; spot K LED, oblique light, zoom 2.0x



Aphid; spot K LED, oblique light, zoom 3.0x

ZEISS Stemi 305 at Work

- › In Brief
- › The Advantages
- › **The Applications**
- › The System
- › Technology and Details
- › Service



Indexable insert; ringlight full circle, zoom 0.8x

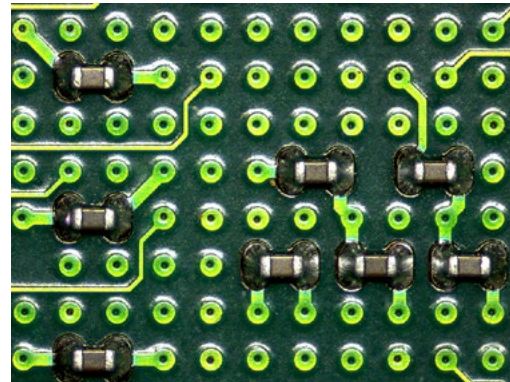

Printed circuit board; ringlight quarter circle, zoom 1.5x, front optics 0.75x

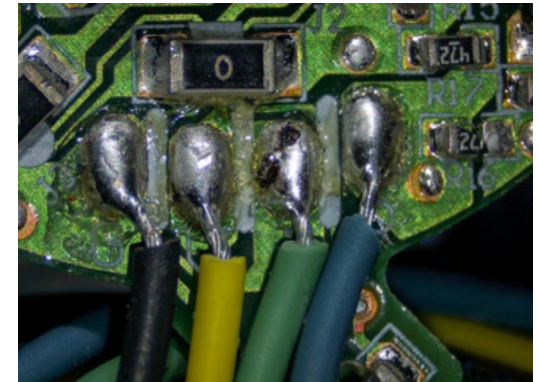

Hand soldered joints; ringlight, full circle

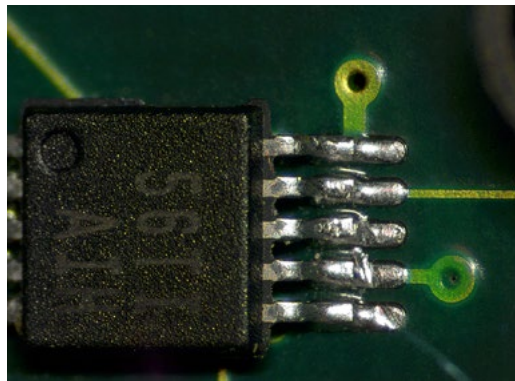

Damaged solder contact; ringlight quarter circle, zoom 3.5x, front optics 0.75x

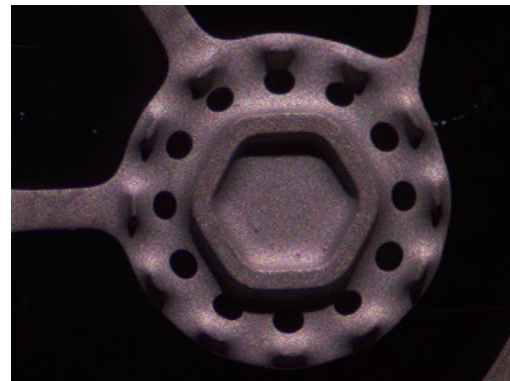

Automotive component; spot K LED, oblique light, zoom 1.5x, front optics 0.75x

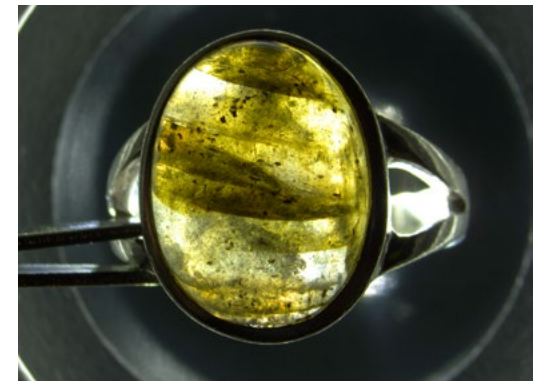

Ring with Labradorit; transmitted light darkfield

Your Flexible Choice of Components

- › In Brief
- › The Advantages
- › The Applications
- › **The System**
- › Technology and Details
- › Service



1 Microscope

- Stemi 305 (binocular)
- Stemi 305 trino (phototube, 50/50 division to the left, integrated c-mount camera adapter 0.5x)
- Stemi 305 cam (integrated 1.2 Megapixel Wi-Fi camera)

Microscope Sets

- Stemi 305 EDU
- Stemi 305 LAB
- Stemi 305 MAT

2 Interchangeable Optics

- Eyepieces: 10x/23 Br. Foc (included), 16x/14 Br. Foc, 25x/10 Foc
- Front optics: 0.5x, 0.75x, 1.5x, 2.0x



3 Illumination

- LED illuminators to stands K: spot, double spot gooseneck, segmentable ringlight, flat or mirror-based transmitted light stands
- Controller K – for standalone use integrated camera, near vertical spot or ringlight K
- Fiberoptic cold light sources CL4500 LED and CL1500 Hal with spot, annular ring, linear, vertical, diffuse and area illuminators, fiber optic transmitted light unit
- Polarization equipment for filters for spots, ringlights and transmitted light units

Illumination Techniques

Reflected and transmitted light:
brightfield; darkfield; polarization; oblique light

4 Stands

- Space saving table top stand K
- Stand K EDU with reflected light (=RL) LED electronics and flat transmitted light unit



- Stand K LAB with RL LED electronics and mirror-based transmitted light unit
- Stand K MAT with RL LED electronics and ESD features (antistatic)
- Large table top stand N
- Boom stands A and SDA, tilting arm stand U

5 Accessories

Eyepiece reticles, gliding, ball/socket and rotating stages, ergo hand rest for stand K LAB

6 Software

- ZEN lite imaging software
- Labscope/Matscope iPad imaging apps

7 Recommended Cameras

- Axiocam ERc 5s
- Axiocam 105 color
- Axiocam ICc 1
- Axiocam ICc 5

Your Flexible Choice of Components

- › In Brief
- › The Advantages
- › The Applications
- › **The System**
- › Technology and Details
- › Service

Microscope Sets for: Education



- Binocular tube
- Integrated near vertical illumination
- LED spot, zoomable and height-adjustable, for oblique and grazing light illumination with strong shadow
- Flat transmitted light base for brightfield and darkfield illumination
- Optional: polarization equipment for spot and transmitted light
- Order number: 435063-9010-100

Laboratory



- Binocular tube
- Integrated near vertical illumination
- Double arm gooseneck, self-carrying, for variable oblique light illumination with distinct shadow effect
- Tiltable mirror base for brightfield, darkfield and oblique light illumination
- Optional: ergonomic hand rest, polarization equipment for spots and transmitted light
- Order number: 435063-9020-100

Industry



- Binocular tube
- Integrated near vertical illumination
- LED segmentable ring light for shadow free ring illumination and oblique light segment illumination: half circle, quarter circle, two-spot
- Rotating illuminating segments
- ESD properties: antistatic coating of microscope body and stand
- Order number: 435063-9030-100

System Overview

- › In Brief
- › The Advantages
- › The Applications
- › **The System**
- › Technology and Details
- › Service

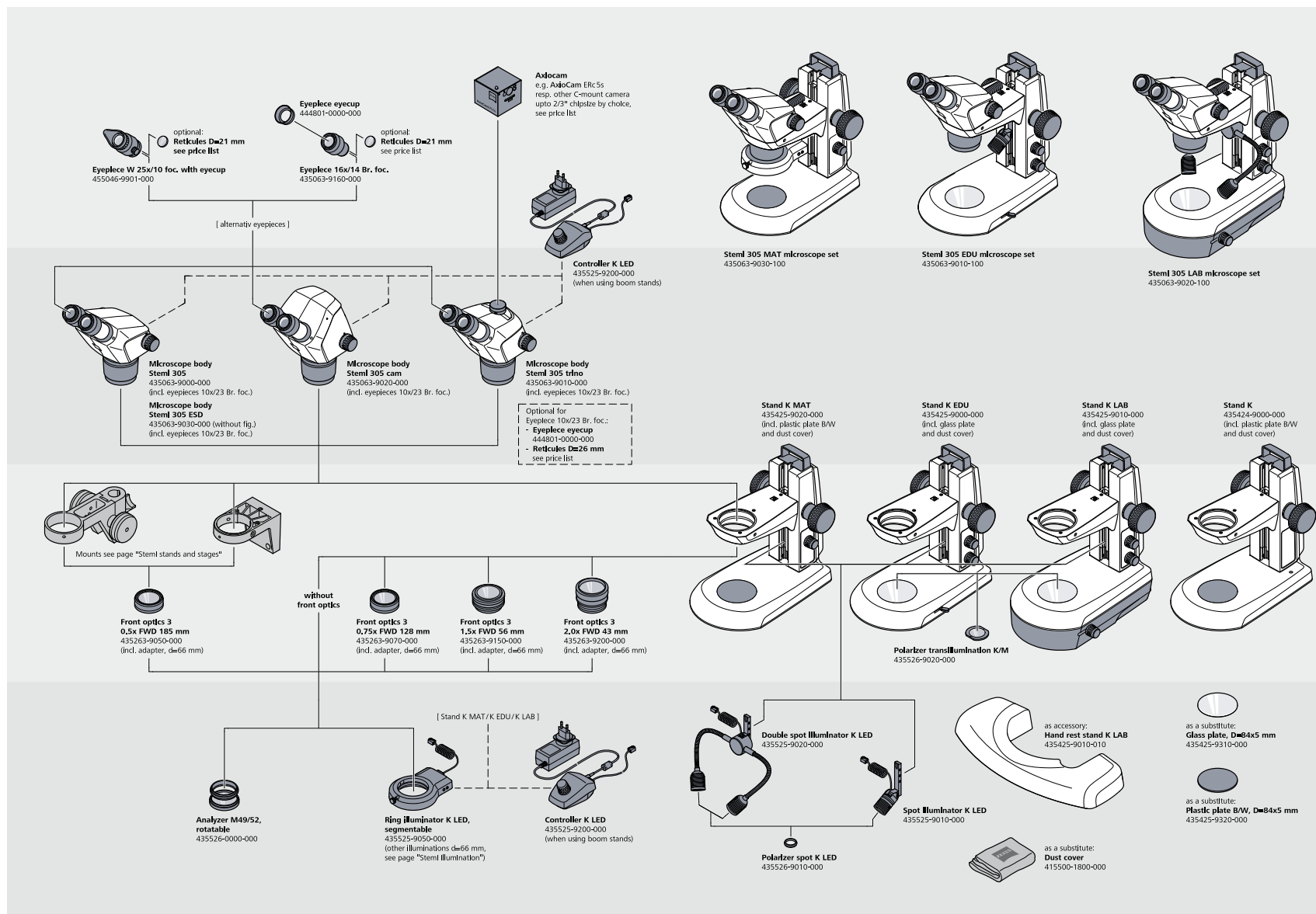

System Overview

- › In Brief
- › The Advantages
- › The Applications
- › **The System**
- › Technology and Details
- › Service

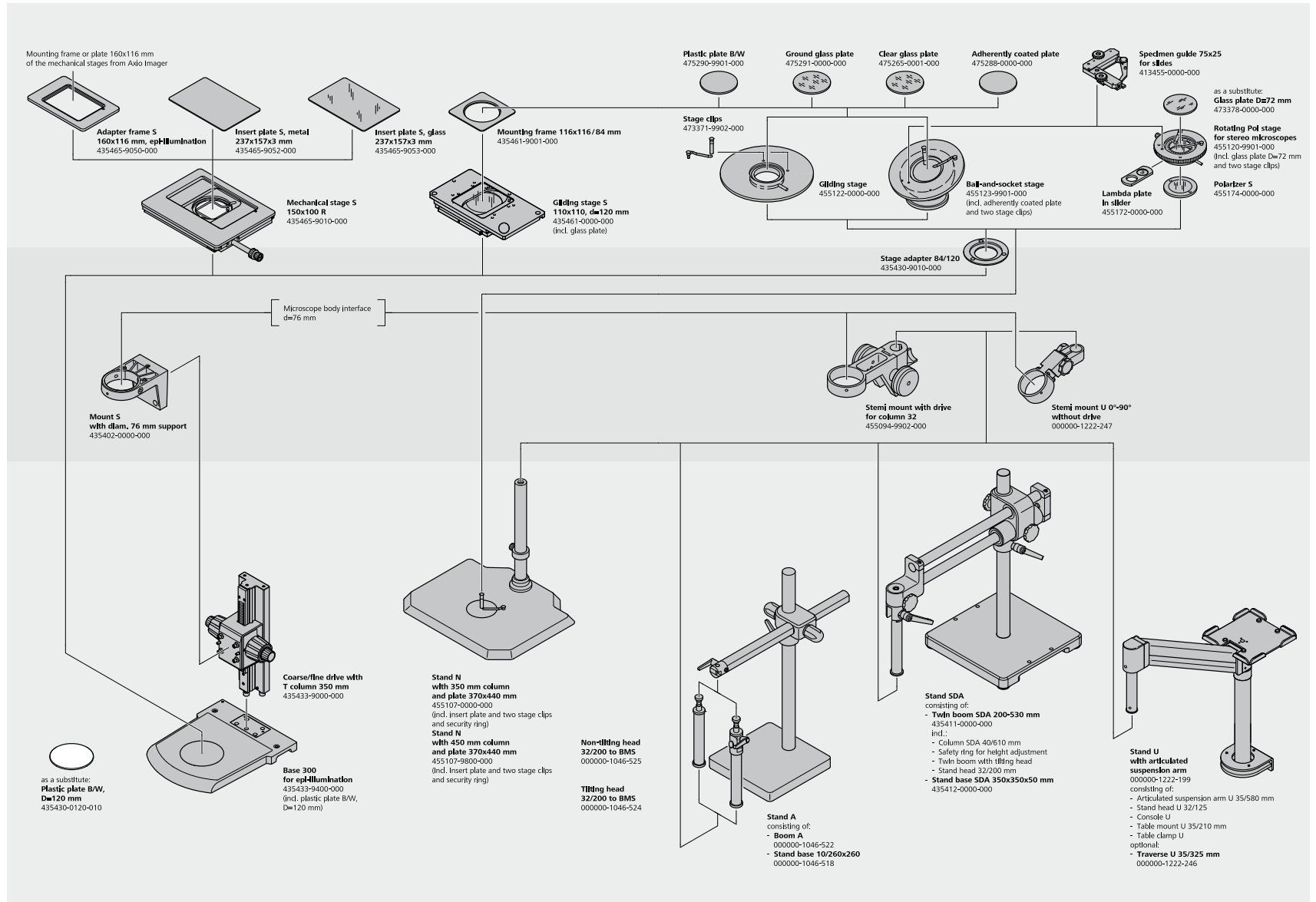

System Overview

- › In Brief
- › The Advantages
- › The Applications
- › **The System**
- › Technology and Details
- › Service

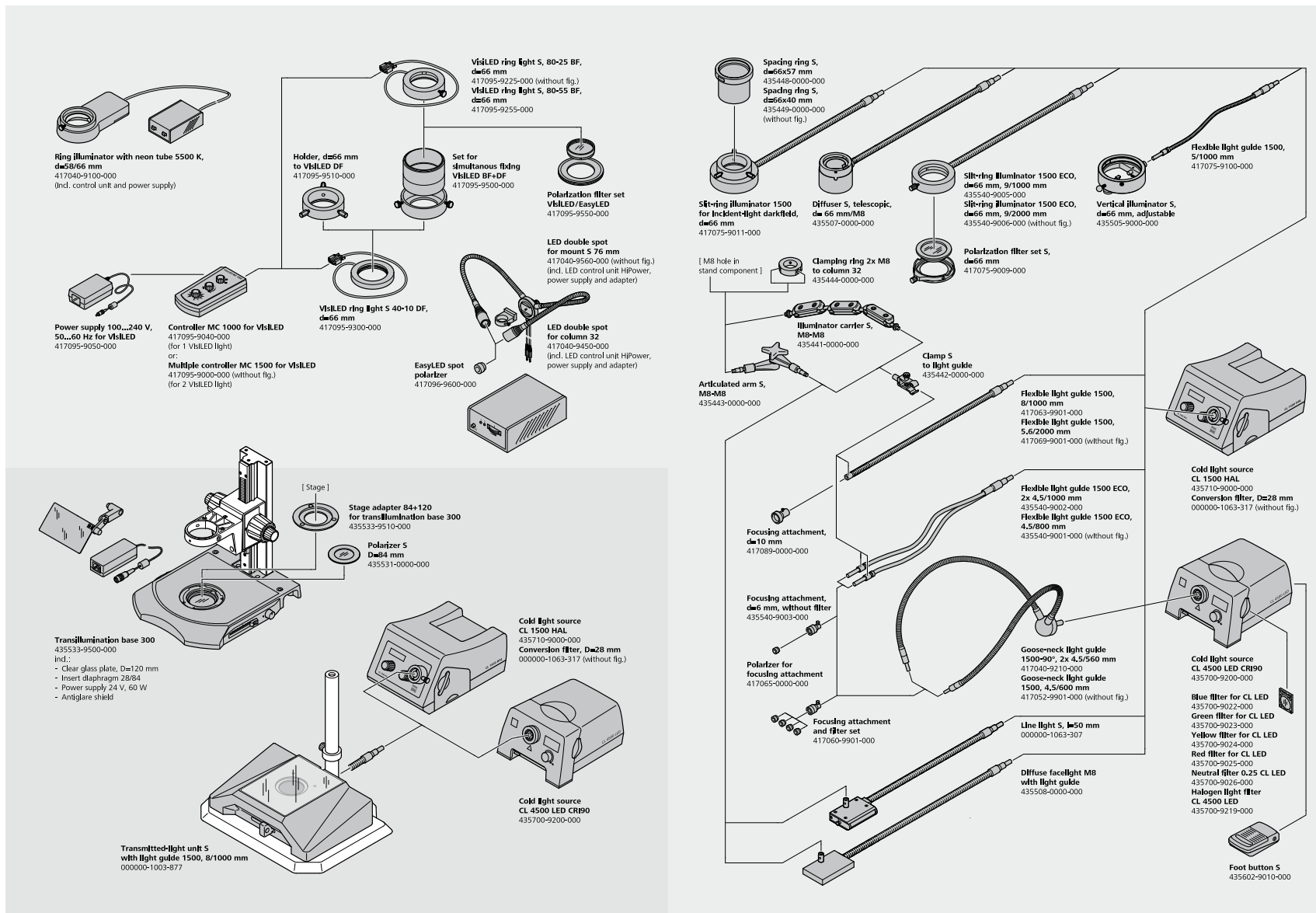

Technical Specifications

- › In Brief
- › The Advantages
- › The Applications
- › The System
- › **Technology and Details**
- › Service

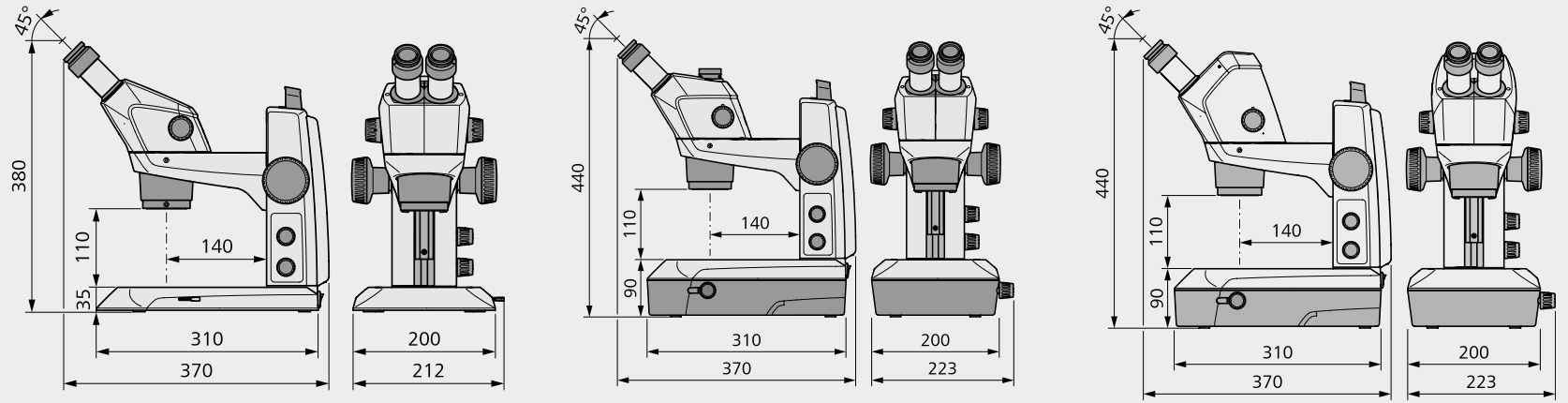

ZEISS Stemi 305		PL 10x23 Br Foc				PL 16x14 Br Foc				PL 25x10 Foc			
Front Optics	FWD	Total Magnification		Object Field [mm]		Total Magnification		Object Field [mm]		Total Magnification		Object Field [mm]	
		Min. Zoom	Max. Zoom			Min. Zoom	Max. Zoom			Min. Zoom	Max. Zoom		
0.5	185	4	20	57.5	11.5	6.4	32	35	7.0	10	50	25.0	5.0
0.75	128	6	30	38.3	7.7	9.6	48	23.3	4.7	15	75	16.7	3.3
1x (without FO)	110	8	40	28.8	5.8	12.8	64	17.5	3.5	20	100	12.5	2.5
1.5	56	12	60	19.2	3.8	19.2	96	11.7	2.3	30	150	8.3	1.7
2.0	43	16	80	14.4	2.9	25.6	128	8.8	1.8	40	200	6.3	1.3

Technical Specifications

- › In Brief
- › The Advantages
- › The Applications
- › The System
- › **Technology and Details**
- › Service

Overall	
Type of Microscope	Stereo microscope, Greenough design
Design Principle	Two zoom systems, tilted by the stereo angle
Stereoscopic View	Three-dimensional observation through eyepieces
Optical Data Basic System (Eyepieces 10x, No Front Optics)	
Magnification Range	8x – 40x
Free Working Distance	110 mm
Maximum Resolution	200 Lp/mm – 2.5 µm
Maximum Object Field Diameter	29 mm
Optical Data with Interchangeable Optics (Eyepieces, Front Optics)	
Accessible Magnification Range	4x – 200x
Free Working Distances	43 – 185 mm
Maximum Resolution	400 Lp/mm – 1.25 µm
Maximum Object Field Diameter	58 mm
Microscope Bodies	
Manual Zoom, Zoom Range	5:1 (0.8x - 4.0x)
Quality of Zoom Optics	Low distortion, crisp in contrast
Parfocality of Zoom Optics	Object remains focused while zooming
Viewing Angle	45°
Adjustment of Interocular Distance	55 - 75 mm
Zoom Click Stops	Five positions: 0.8x, 1x, 2x, 3x, 4x
Maximum Field Number	23 mm
Integrated near Vertical LED Illumination	Integrated in each Stemi 305 microscope body, powered by stands H EDU/LAB/MAT or controller K LED, illumination angle 10° towards optical axis
Documentation Features Stemi 305 trino	Photoport with 50/50 split to the left, integrated camera adapter 0.5x, c-mount interface
Documentation Features Stemi 305 cam	Integrated 1.2 Megapixel Wi-Fi camera, wireless transmission of image signal* (*Please ask your local contact for approval in your country.)
Interfaces	
Front Optics and Polarization Analyzer	M52
Eyepieces	d = 30 mm
Stemi Mounts	d = 76 mm
Illuminators	d = 66 mm
Each Microscope Body incl. Eyepieces 10x/23 Br. Foc and Spiral Cable RJ12	

Technical Specifications

- › In Brief
- › The Advantages
- › The Applications
- › The System
- › **Technology and Details**
- › Service

Compact Stand System K	
Stand Base	W190 × D310 × H35 mm (K LAB: H90 mm)
Working Surface	W160 × D195 mm
Column with Stemi Mount, Handle and Focus Drive, Friction Adjustable	
Height	250 mm
Lifting Range	145 mm
Interface to Microscope	d = 76 mm
Interfaces for Stages	d = 84 mm
Interface for TL Polarizer	d = 45 mm
Interface for LED Spot K and Double Spot K	Slot in focus drive
Incl. Glass Plate or Black/White Plate D = 84 × 5 mm, Dust Cover	
Stands K, Separate Versions	
Stand K mechanical stand without electronics with 2× M8 interface for supporting arms of fiberoptic light guides	
Stand K MAT with reflected light LED electronics and ESD features (antistatic surface resistance)	
Stand K EDU with reflected/transmitted light LED electronics and built-in flat transillumination unit (brightfield/darkfield)	
Stand K LAB with reflected/transmitted light LED electronics and built-in mirror transillumination unit (brightfield/darkfield/oblique)	
Electronic Features of Stand K EDU/LAB/MAT	Separate control knobs for reflected/transmitted light (on/off/dimming) 2 sockets to adapt Stemi 305 bodies (integrated vertical illumination, Wi-Fi camera) and a second reflected light illuminator K Separate control of vertical/second RL illumination by pushing the reflected light dimming knob (A → B → mixed light A+B → Off → ...)
Integrated Power Unit, Easily Changeable	12 V DC 24 W / 100 ... 240 V AC / 50 ... 60 Hz
Optical Specifications K LED Illuminations (For Stands K EDU/MAT/LAB)	
Color Temperature	Typ. 5600 K
Lifetime (Lumen Maintenance)	Typ. 25000 h (operation time until the light intensity degraded to 70% of initial value)
Integrated near Vertical LED Illumination	Brightness max. typ. 20000 lx (Stemi 305 focused)
LED Spot K, Height Adjustable, Zoomable	Brightness max. typ. 30000 lx (object field center, LED spot mounted to stand K)
LED Double Spot with Goosenecks, Self Carrying	Brightness max. typ. 90000 lx (object field center, double spot mounted to stand K)
Segmentable Ringlight K	Brightness max. typ. 55000 lx (mounted to Stemi 305 body, object focused) Working distance 50 mm – 300 mm (also suitable for front optics 2.0x, when shifted upwards)
Built-in Transmitted Light LED Illuminations:	
Flat transillumination unit (stand K EDU)	Brightness max. typ. 20000 lx (brightfield)
Mirror transillumination unit (stand K LAB)	Variable contrasting by rotatable and slidable mirror, brightness max 25000 lx

Technical Specifications

- › In Brief
- › The Advantages
- › The Applications
- › The System
- › **Technology and Details**
- › Service

Stands N	
Large Stand Base	W440 × D370
Column Height/Diameter	350 or 450 mm/d = 32 mm
Interface for Stages	d = 84 mm
Incl. Black/White Plate D = 84 and Security Ring	
Additionally Needed: Stemi Mount for Column 32 with Drive	
Stages for Interface d = 84 mm	
Gliding stage ±20 mm, rotatable, d = 84 mm	
Ball-and-socket stage ±30°, rotatable, d = 84 mm	
Rotating polarization stage for stereo microscopes, with interfaces for polarizer and lambda plate	
Boom Stands	
Single Arm Boom Stand A	
Stand Base Dimensions/Weight	W260 × D260 × H20; 13 kg
Boom Length/Diameter	600 mm/d = 37 mm
Working Radius (Incl. Stemi Mount)	Max. 615 mm
Tilting or Non-tilting Head, Height/Diameter	200 mm/d = 32 mm
Double Arm Boom Stand SDA	
Stand Base Dimensions/Weight	W350 × D350 × H50; 31 kg
Double Arm Boom Stand, Ball-bearing, Length	670 mm
Working Radius (Incl. Stemi Mount)	Max. 695 mm
Tilting Head Integrated, Column Height/Diameter	200 mm/ d = 32 mm
Tilting Arm Stand U with Articulated Suspension Arm I	
Arm Length / Lifting Range / Load Capacity	580 mm / 500 mm / 2 – 4,8 kg
Working Radius (Incl. Stemi Mount)	735 mm, 1060 mm with traverse S (option)
Table Clamp For Tables Thickness	5 – 75 mm
Stand Head Length/Diameter	100 mm/d = 32 mm
Additionally needed for all boom stands: Stemi mount for column 32 with drive or Stemi mount 0 – 90° without drive	

Technical Specifications

- › In Brief
- › The Advantages
- › The Applications
- › The System
- › **Technology and Details**
- › Service

Fiberoptic Illuminations	
Cold Light Source CL 4500 LED CRI90 with High Power LED Engine	
Light flux at 9 mm fiber output dia.	Typ. 450 lm
Color Temperature	Typ. 5400 K
Color Rendering Index	>90
LED Lifetime (Lumen Maintenance)	50000 h
Light Guide Sensor	Auto on/off
2 Position Filter Slider	2 filters and free opening
Wide-range Supply	Max. 50 W
Flicker free light, silent axial fan, 2.5 mm phone socket for foot button S	
Cold Light Source CL 1500 HAL with 150 W Halogen Reflector Lamp	
Light Flux at 9 mm Optical Output Diameter	Up to 600 lm
LCD Display	Brightness/color temperature/power-on hours
Bulb Lifetime at 80% Dimming (450 lm)	Typ. 150 h
Filter Slider	One filter d=28 mm and free opening
Wide-range supply for flicker free light, silent axial fan	
Light Guides	
One- And Two Branch Flexible Arm Spot Light Guides ■ Additional supporting arms needed	Oblique light, crisp 3D impression by distinct shadows
One- and Two Branch Gooseneck Spot Light Guides	Oblique light, self-carrying, crisp 3D impression by distinct shadows
Annular Ring Illuminators d = 66 mm for Brightfield	Shadow free illumination
Annular Ring Illuminators d = 66 mm for Darkfield	Shadow free illumination
Line Light 50 mm	For homogeneous grazing light
Vertical Illuminator	For illumination of deepenings
Diffusor S	Shadow free all sided soft light, „cloudy day illuminator“, avoiding glare
Diffuse Area Light	One sided „soft“ illumination, avoiding glare but creating certain shadows
Illumination Accessories	
Focusing Optics for Spot Light Guides	Increasing brightness
Polarizing Equipment for Spots and Ringlights	Reducing reflections

Technical Specifications

- › In Brief
- › The Advantages
- › The Applications
- › The System
- › **Technology and Details**
- › Service

Ambient Conditions	
Storage (in Packaging)	
Permissible Ambient Temperature	+10 to +40 °C
Permissible Humidity	Max. 75 % to +35 °C (without condensation)
Transportation (in Packaging)	
Permissible Ambient Temperature	-40 to +70 °C
Operation	
Permissible Ambient Temperature	+10 to +40 °C
Permissible Humidity	Max. 75 %
Air Pressure	800 hPa to 1060 hPa
Degree of Pollution	2
Area of Use	Closed spaces
Max. Altitude	Max. 2000 m
Operational Data – Power Supply, Microscope, Controller K LED	
Protection Class	II
Protection Type	IP 20
Electrical Safety	Acc. to DIN EN 61010-1 (IEC 61010-1) allowing for CSA and UL specification
Degree of Pollution	2
Overvoltage Category	2
Power Supply	100 to 240 V ±10 %
Converting the line voltage is not necessary!	
Power Frequency	50 Hz – 60 Hz
Power Consumption: Stage Power Supply with Microscope	Max. 40 VA
Output Power Supply Microscope and Controller K LED	12 V DC, max. 2 A
Input Output Power Supply Microscope and Controller K LED	100 – 240 V, 50 – 60 Hz, max. 0.55 A

Count on Service in the True Sense of the Word

- › In Brief
- › The Advantages
- › The Applications
- › The System
- › Technology and Details
- › **Service**

Because the ZEISS microscope system is one of your most important tools, we make sure it is always ready to perform. What's more, we'll see to it that you are employing all the options that get the best from your microscope. You can choose from a range of service products, each delivered by highly qualified ZEISS specialists who will support you long beyond the purchase of your system. Our aim is to enable you to experience those special moments that inspire your work.

Repair. Maintain. Optimize.

Attain maximum uptime with your microscope. A ZEISS Protect Service Agreement lets you budget for operating costs, all the while reducing costly downtime and achieving the best results through the improved performance of your system. Choose from service agreements designed to give you a range of options and control levels. We'll work with you to select the service program that addresses your system needs and usage requirements, in line with your organization's standard practices.

Our service on-demand also brings you distinct advantages. ZEISS service staff will analyze issues at hand and resolve them – whether using remote maintenance software or working on site.

Enhance Your Microscope System.

Your ZEISS microscope system is designed for a variety of updates: open interfaces allow you to maintain a high technological level at all times. As a result you'll work more efficiently now, while extending the productive lifetime of your microscope as new update possibilities come on stream.



Profit from the optimized performance of your microscope system with services from ZEISS – now and for years to come.

>> www.zeiss.com/microservice



Carl Zeiss Microscopy GmbH
07745 Jena, Germany
microscopy@zeiss.com
www.zeiss.com/stemi305



We make it visible.